

10/100Mbps Portable 2-Port Streams Generator & Network TAP

NuDOG-101T OVERVIEW

NuDOG-101T is a handheld device with two ports for Ethernet testing. The main functions of NuDOG-101T include multi-streams generation, TAP/Loopback test, and NIC emulation.

Connecting NuDOG-101T to its mini-USB port makes it possible for system configurations and managements.

NuDOG-101T is an ideal device for in-field testing.

NuDOG-101T can work along with a series of utility softwares that qualify industrial standards such as RFC 2889, RFC 2544, and QoS. With these utilities, NuDOG-101T is able to conduct throughput test, latency test, error filtering test, forwarding test, and so on. These utility softwares provide a user-friendly interface for making different test configurations and setting test parameters and criteria. More optional softwares are available for extended test requirements.

With its unique Universal Stream Counter (USC), NuDOG-101T offers real-time statistics of network events during packet monitoring and capturing.

With these advantageous features, NuDOG-101T is your best partner for LAB researching and in-field troubleshooting.



FEATURES & ADVANTAGES

- Hardware based wirespeed streams generation, analysis, network TAP and NIC
- High precision performance for measuring throughput, latency, packet loss and disordered sequence
- Wirespeed traffic capturing with programmable filter and trigger criteria
- Supports Universal Stream Counter (USC) with 128 streams
- RFC 2544 test suite
- RFC 2889 test suite
- Layer 1 and Layer 2 loopback test
- High precision 1 ppm temperature-compensated oscillator provides accurate clock speed to ensure the reliability of the tests
- Injecting errors in transmitted traffic to simulate and test abnormal situations
- Real-time statistics for each port, including transmitted /received frame for VLAN, IPv4, IPv4 fragment, IPv4 extension , ICMP, ARP, total bytes/packets, CRC, IPCS error and over-and-under size frames
- User-friendly interface that supports various parameter configurations and meets various test requirements
- 256Mbits packet capture buffer per port

APPLICATION MODE & BLOCK DIAGRAM

• **Stream Generation Mode:**

In Streams Generation mode, NuDOG-101T generates bi-directional network streams for test requirements as the illustration below.

Both NuDOG-101T's Port A and Port B can generate and receive test streams. The test streams are sent and returned to the same NuDOG-101T for DUT (device under test) analysis.

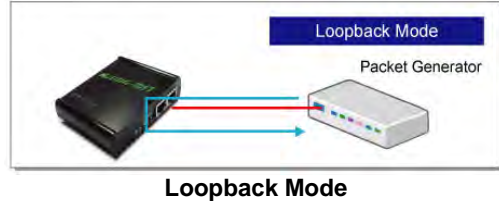
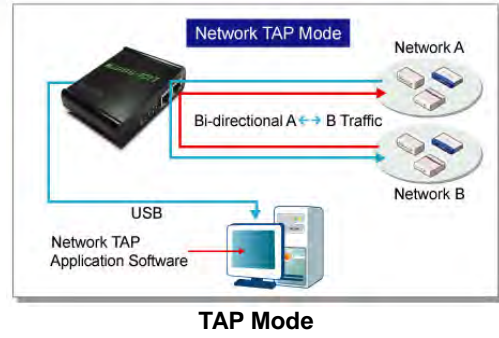
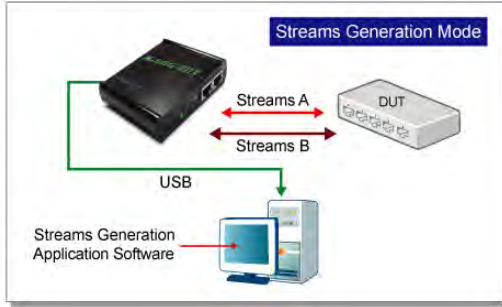

• **TAP/Loopback Mode:**

In TAP mode, NuDOG-101T can monitor any data that flows through it. Network TAP is a method of monitoring network's situation dynamically without interference. NuDOG-101T can tap bi-directional or uni-directional traffic from different sides (port A and port B) and also provides abundant packet counters. In Loopback mode, NuDOG-101T resends the incoming streams back to the source.

• **NIC Mode:**

In this mode, NuDOG-101T simulates network interface card (NIC).

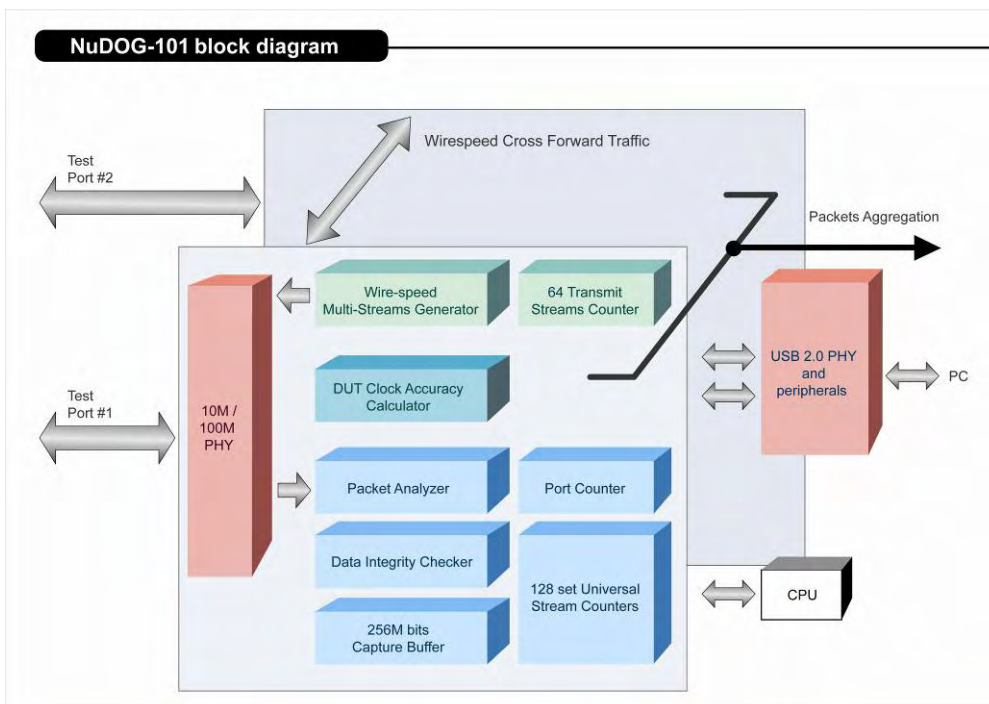
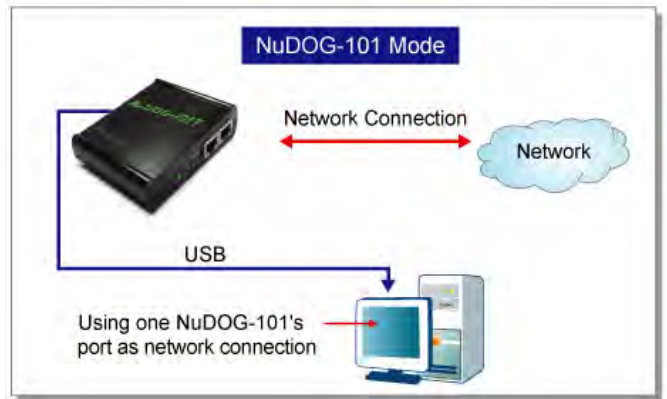

NuDOG-101T SPECIFICATIONS

| NuDOG-101T | |
|--|---|
| Supported Frame Format | <ul style="list-style-type: none"> Ethernet Type II frame IEEE 802.3 frame |
| Interface Ports & LEDs | |
| Interface Ports | Test Ports <ul style="list-style-type: none"> 10/100 Mbps Half/Full Duplex RJ 45 Ports x 2 |
| | Other Ports <ul style="list-style-type: none"> Standard-B Receptacle USB Port x 1* |
| LEDs | <ul style="list-style-type: none"> PWR: Power status Capture A: Capture Mode for A port is activated Capture B: Capture Mode for B port is activated USB: USB connection status PG/TAP: Packet Generation in TAP/Loop Mode or NIC Mode |
| Application Mode | |
| Application Mode | SG Mode SG (Stream Generation) Mode allows NuDOG-101T to generate bi-directional network streams and transmit them to DUT |
| | TAP/Loopback Mode NuDOG-101T monitors any data that flows through it and also provides loopback and abundant packet counters |
| | NIC Mode NIC (Network Interface Card) Mode allows NuDOG-101T to simulate as an NIC connecting to the PC via USB port |
| Functional Specification/Hardware Counter | |
| Functional Specification | <ul style="list-style-type: none"> Active TAP without interfering monitored traffic Variation of DA/SA and VLAN ID in increase, decrease, or random that can test the addressing capability of the DUT Rapid-Matrix mode: Up to 64 base-streams Frame Length: Fixed from 64 ~16k bytes or random Inter Frame Gap Count: 96ns~1.073 Sec Payload in Frame: Specific payload or random pattern Error Generation: CRC, Alignment, Dribble bits, Undersize frame, Oversize frame Capturing Network events with SDFR (Self-Discover Filtering Rules) 2nd level CRC check and transmission sequence check Support Jumbo Frame (up to 16K bytes) Two Capture Buffer Mode: 2KB packet length mode; 16KB packet length mode Maximum Packet Length for Loopback: 2K bytes DUT oscillator measuring Support 1 USC (Universal Stream Counter) with 128 streams |
| Hardware Counter | <ul style="list-style-type: none"> Transmitting/Receiving: Tx/Rx Packet, Tx/Rx Byte, Tx/Rx Rate Collision Counter: Tx Collision, Tx Single Collision, Tx Multi Collision, Tx Excess Collision Error Counter: Dribble Error, Alignment Error, CRC Error, DI Error, IPCS Error, Error & Loss Packet Packet Size Statistics Counter: Under Size, 64, 65-127, 128-255, 256-511, 512-1023, 1024-1522, Over Size Layer 2 and Layer 3 Packet Counter: Broadcast, Multicast, Unicast, VLAN, IPv4, IPv4 Fragment, IPv4 Extension, ICMP, ARP, and Pause. SDFR (Self-Discover Filtering Rules) Trigger Counter |
| Utility Softwares (Optional) | |
| Utility Softwares | <ul style="list-style-type: none"> DApps-NIC: NIC simulation suite DApps-TAP: Ethernet TAP suite base on TAP, Layer 1 loopback and Layer 2 loopback mode with real streams counter and streams chart DApps-SG: Control suite for multiple streams generator DApps-2544: Test Suites for RFC 1242 and RFC 2544 DApps-2889: Test Suites for RFC 2285 and RFC 2889 (partial) DApps-QoS: QoS testing based on VLAN item and IP/UDP item of Layer3 DApps-MPT: Automated Ethernet device batch tests for mass-production line or network device certifications in laboratories |
| Main Frame Spec | |
| Dimension | 95mm x 76.6mm x 19.6mm |
| Net Weight | Approx. 200g |
| Temperature | <ul style="list-style-type: none"> Operating: 0°C~ 40°C (32°F~ 104°F) Storage: 0°C~ 50°C (32°F~ 122°F) |
| Humidity | <ul style="list-style-type: none"> Operating: 0% ~ 85% RH Storage: 0% ~ 85% RH |
| Power Source | Powered by 5 Pin Mini-B Receptacle USB Port |

*Please note that when connecting NuDOG-101T with PC via its USB port, DO NOT use a USB hub

UTILITY SOFTWARES (OPTIONAL)

DApps-TAP: Network TAP/Loopback Utility

With DApps-TAP, all data streams between two network ports can be duplicated and sent to PC via NuDOG-101T's Mini-USB Port for monitoring and analyzing. The user can specify conditions to filter the packets wanted with DApps-TAP application software. It reduces USB port's network traffic and also cuts down PC resource consumption while dealing with large quantity of packets.

DApps-SG: Control Suite for Multiple Streams Generator

DApps-SG provides a powerful and sophisticated virtual front control panel to manage this device. Two test ports can be configured independently with parameters to define multiple streams and capture capabilities. Traffic for various network protocols can be customized, transmitted, and received on each port. Comprehensive statistics give users an in-depth analysis of the DUT performance.

DApps-NIC: Network Interface Card Simulation Suite

NuDOG-101T has a mini-USB port for PC connection. In addition to network TAP, system control and system upgrade functions. NuDOG-101T can also be used as a network interface card. With control software and NuDOG-101's hardware conversion, network data streams can flow between NuDOG-101T's USB and network port.

DApps-2544: Test Suit Based on RFC 2544

DApps-2544 is a user-friendly and automatic test suite based on industry-standard RFC 2544. It generates and analyzes packets to evaluate the Throughput performances, Latency, Packet Loss, and Back-to-Back of Ethernet switches or routers via this device. The real-time test results display and customized report provide an effective way when examining the DUT.

DApps-2889: Test Suit Based on RFC 2889

DApps-2889 is a user-friendly and automatic test suite based on industry-standard RFC 2889 (partial) to test the DUT. RFC 2889 provides methodology for benchmarking for local area network (LAN) switching devices, forwarding performance, congestion control, latency, address handling and filtering. It extends the methodology already defined for benchmarking network interconnecting devices in RFC 2889.

DApps-MPT: Automatic batch tests for Ethernet device

DApps-MPT is an accurate and efficient software suite for mass-production scale test or batch network test. Various packet generation and reception testing items could be configured to pre-defined testing modes. The utility of DApps-MPT can load testing models easily. All simple and visualized results and detailed testing logs are available to access upon demand. DApps-MPT is a powerful and convenient tool to apply on this device.

DApps-QoS: QoS Testing covering Layer 2 & Layer 3

Base on RFC 1242, RFC 2544, RFC 2285, RFC 1700 and IEEE 802.1Q, Network QoS (quality of service) is a way to classify the transmission priority of packets while the volume of to-be-transmitted packets is beyond the Ethernet switch or router's throughput capability. Packets with higher priorities are processed and transmitted first. For Ethernet frame, each packets can be tagged with a VLAN ID and CoS (class of service), and Layer 3 IP/UDP packets are marked according to the type of service they need. For Ethernet switch or router that supports QoS, packets with higher CoS priority should be transmitted first if network traffic is congested. DApps-QoS can limit acceptable network traffic at receiving port, analyze the traffic distribution of packets with different priority received from DUT (router or switch), and test the performance of Layer 3 Router, Switch with QoS function.

TECHNICAL TERMS

NuDOG-101T is an all-purpose handheld network test device that has many innovative technologies.

Rapid-Matrix

Rapid-Matrix, especially designed by Xtramus for generating multi-stream traffic per port simultaneously, is used to verify functions and performance of Gigabit Ethernet devices/solutions/networks.

Features & Advantages

Rapid-Matrix is a technology that can generate multi-stream traffic simultaneously with different kinds of frames containing almost any required protocol headers, tags and payload for each port

In traditional network test procedures, testing different functions sequentially always takes lots of time, and if the test equipment is not sufficient enough, cost of time will be high. Unlike traditional test procedures in other test equipments, Rapid-Matrix technique activates multi-task test to DUTs simultaneously. This mechanism also synchronizes the test procedure to all DUTs under test; hence, the test duration of a multi task test for all DUTs is predictable and the test duration is reduced dramatically.

Generate up to 64 Streams per Port

Rapid-Matrix consists of 64 individual entries for each port. Each entry has its own independent settings for a unique data stream. Multiple entries can be correlated to compose a complicated data stream.

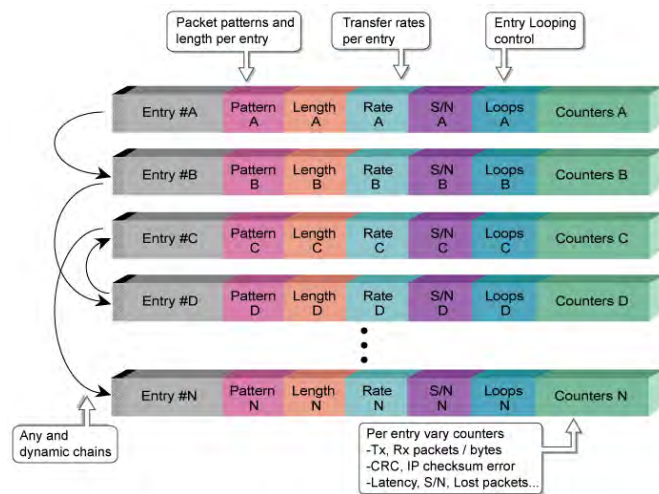

Network TAP

Network TAP is a way to monitor the network without interfere the running network. All data streams between point A and B can be duplicated and sent to PC for analysis. Application tool DApps-TAP and NuDOG-101T can be installed on PC for network analysis.

Active TAP

Normal TAP only redirects all traffic flow between two locations into the PC and analyzes the traffic. If the traffic flow is at its peak, it is possible that the PC won't be able to deal with heavy traffic.

Active TAP handles all packet flows through the TAP device. NuDOG-101T is an Active TAP device that has these functions:

- **Packet Trigger:** Configure a criteria or content of packet that will be filter out for analysis.
- **Filter:** Packet data that fits certain criteria is redirect to the USB TAP port.
- **Packet Capture:** Packet data that fits certain content or criteria is captured and saved to the memory buffer of NuDOG-101T.
- **Comprehensive Real-Time Statistics:** Frames with varied size, packets, and certain error are all recorded in the real-time statistics counter.
- **Selectable Packet Redirect Mode:** Different from Aggregate, NuDOG-101T can also redirect uni-directional packets back to its own single USB port.

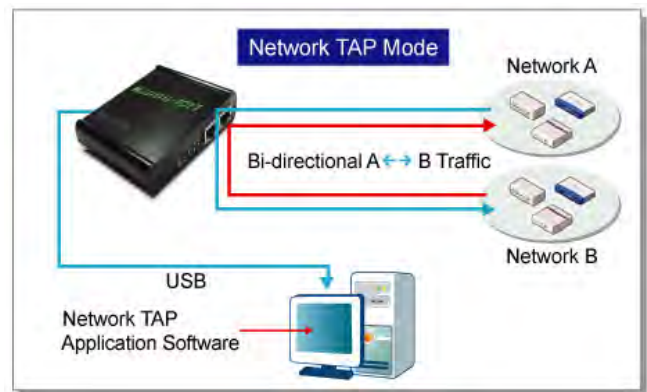

SDFR

Self-Discover Filtering Rules

SDFR (Self-Discover Filtering Rules) is a technology that makes packet capturing/filtering over Ethernet easy and convenient.

SDFR's User-friendly interface can display values such as Source IP, Destination IP and so on. All these values (one single value or a specific range of values) can be input directly without calculating mask.

All captured packets are displayed in real-time without intervening network flow, and SDFR values can be changed dynamically during capture procedure.

SDFR parameters include filter of Layer 2 **Destination MAC Address, Source MAC Address, VLAN ID, Layer 3 Destination IP Address, Source IP Address, Destination Port, and Source Port**. Each filter is independent and can be activated in any combinations.

USC

Universal Streams Counter

| XID # | Line Rate (Mbps) | Packets | Bytes | Loss Packets | S/N Mi |
|-------|------------------|---------|-------|--------------|--------|
| 0 | n/a | n/a | n/a | n/a | n/a |
| 1 | n/a | n/a | n/a | n/a | n/a |
| 2 | n/a | n/a | n/a | n/a | n/a |
| 3 | n/a | n/a | n/a | n/a | n/a |
| 4 | n/a | n/a | n/a | n/a | n/a |
| 5 | n/a | n/a | n/a | n/a | n/a |
| 6 | n/a | n/a | n/a | n/a | n/a |

When monitoring data flows in a network environment with Network TAP devices, it is common to use packet analyzers (or sniffers) for capturing and analyzing packet frames. However, information acquired this way may be too vast and complicated for pinpointing the possible cause of network/product problems.

Unlike these common packet analyzers or sniffers mentioned above, Universal Stream Counter (USC) offers real-time statistics of network events during packet monitoring and capturing.

Both of NuDOG-101's ports support Universal Stream Counter (USC). Each port contains 1 sets of USC with packet filtering rules based on SDFR mentioned above and contains statistics including:

- Line Rate (Mbps)
- S/N Miss
- Packets
- IPCS Error
- Bytes
- Latency (μs)
- Packet Loss

Features & Advantages of USC

➤ Wirespeed Performance:

The performance of Multi-stream Counter can support up to wirespeed (100% utilization of Gigabit Ethernet traffic). Receiving frames are processed in real time.

➤ Flexible Protocol Support:

Several often-used protocols (like IPv4) are served as pre-defined patterns for Multi-stream Counter's trigger conditions. Multi-stream Counter also supports user-defined patterns by SDFR. Proprietary protocols or private headers/ tags can also be triggered by Multi-stream Counter based on user- SDFR.

➤ Pre-filtering to Trigger Designated Packets:

Multi-stream Counter can correlate with filtering. Incoming packets will be filtered first. Only packets meet filtering criteria are forwarded to Multi-stream Counter. Filtering options are very flexible in order to meet different testing requirements. Several default parameters are available for frequently-used protocols such as IPv4 and etc. User defined triggers are also supported for custom testing requirements.

2nd Level CRC (Data Integrity) Check

2nd level CRC (Cyclic Redundancy Check Code) Check, an advanced data integrity check function, is the checksum computed based on the contents of the frame from the offset through the end of the data field, inclusive. If data is corrupted by DUT and FCS is affected by the error data, 2nd level CRC check will serve as the checksum. Any mismatches of transmitted and received packets are recorded as error of 2nd Level CRC (Data Integrity) check.

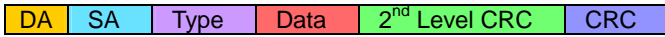

Loopback Test

Loopback test is widely used for testing data stream integrity, network cable and connection signal quality through network transmission. For either cable quality or data integrity loopback test, NuDOG-101T can act as a testing traffic generator or a signal/data reflector.

Layer 2 BERT (Bit Error Rate Test)

In Layer 2 BERT, testing data streams comprising Ethernet frames, which carries BERT pattern as payload, are generated and transmitted across NUT (Network under Test) and DUT. These testing data streams will be sent back to their original source for data corruption comparisons.

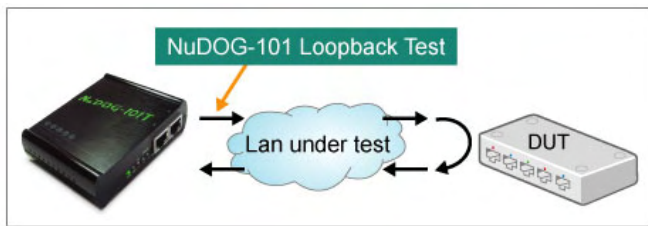

Illustration of Loopback test

Loopback (layer 1 or layer 2) Function Modes

At loopback mode, NuDOG-101T acts as a reflector, resending incoming signal and frames back to the receiving port.

- **Layer 1 Loopback Mode:** NuDOG-101T works as a signal reflector equipped with a signal tester, receiving and reflecting physical signal back to the same physical layer port. Layer 1 Loopback Mode is widely used for signal quality or cable test.
- **Layer 2 Loopback Mode:** NuDOG-101T works as a frame reflector equipped with an Ethernet tester. NuDOG-101T will receive incoming Ethernet frames, swap DA/SA, recalculate Ethernet CRC, and resend revised frames to the receiving port. However, frames categorized as broadcast, multicast or null DA (Destination MAC Address) will not be resend. Layer 2 Loopback Mode is mainly used for frame-based data integrity test.

DUT Oscillator Measuring

With high precision 1 ppm temperature-compensated oscillator, NuDOG-101T can generate network stream with precise frequency to DUT, or measure the frequency of DUT's oscillator for controlling speed of network stream.

By using DApps-SG, the user can evaluate and measure if DUT's oscillator frequency is either faster or slower than the standard speed in ppm scale. The user can also use it as a standard to judge the test results.

NuDOG-101T is embedded with advanced clock reprocessing circuits for measuring DUT clock via Ethernet connection. With built-in, high precision, 1 ppm temperature-compensated oscillator and advanced clock measurement circuit design, NuDOG-101T is capable of performing preliminary clock tests for measuring DUT clock accuracy.

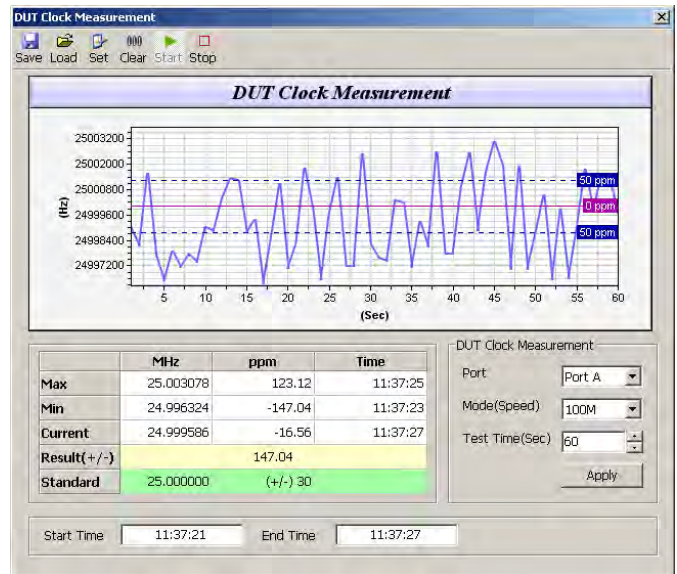

NuDOG-101T HARDWARE OVERVIEW



| NuDOG-101 Hardware Overview | |
|-----------------------------|--|
| A | Mini-USB Port for connecting NuDOG-101T to PC or for power supply. |
| B | Interface Port A/B for connecting NuDOG-101T to DUT or network. |
| C | LEDs that display NuDOG-101T's system status. |

RELATED PRODUCTS

NuDOG-801

Portable 10 Gigabit Wirespeed Streams Generator with 2 SFP+ Ports



NuDOG-301C

Portable 2-Port Gigabit Wirespeed Streams Generator & Network TAP



denk-stain:net
 MEASUREMENT TECHNOLOGY
 Kaiserin-Augusta-Allee 8 ■ 10553 Berlin ■ Germany
 ☎ +49-(0)30-398981-0 📠 +49-(0)30-398981-39
 🌐 sales@denk-stain.com 🌐 www.denk-stain.com
 Vertrieb & Systemintegrator für Carrier + Corporate Networks

Note: Information and specifications contained in this document are subject to change without notice.
 All products and company names are trademarks of their respective corporations.
 Copyright © 2011 Xtramus Technologies, all rights reserved.
 Do not reproduce, redistribute or repost without written permission from Xtramus.
 Doc # PBF_NuDOG-101T_V1.3_ENG_20120716